

VHF amplifier module

BGY145C

T-74-09-01

DESCRIPTION

An RF amplifier module designed for use in transmitters of mobile communications equipment powered by a 12.5 V battery supply.

The module is a two stage transistor amplifier and consists of two RF npn transistors mounted on a ceramic substrate, together with surface mounted components that make up the matching and bias circuits.

The module will provide 27 W RF power into a 50 Ω load, when operated at nominal conditions within the frequency range of 174 to 200 MHz.

PINNING - SOT183A

PIN	DESCRIPTION
1	output
2	V _{S2}
3	V _{S1}
4	input
flange	ground

PIN CONFIGURATION

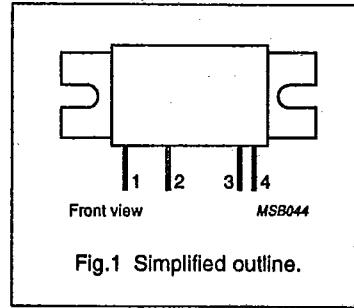

QUICK REFERENCE DATA

Mode of operation: continuous wave.

SYMBOL	PARAMETER	CONDITIONS	MIN.	TYP.	MAX.	UNIT
f	frequency range		174	-	200	MHz
P _L	RF output power	P ₀ = 300 mW	27	-	-	W
G _p	RF power gain	P _L = 27 W	19.5	-	-	dB
η	efficiency	P _L = 27 W	35	-	-	%
V _{S1} , V _{S2}	DC supply voltage		-	12.5	-	V
Z _i	input impedance		-	50	-	Ω
Z _L	output load impedance		-	50	-	Ω

VHF amplifier module

BGY145C

T-74-09-01

LIMITING VALUES

In accordance with the Absolute Maximum System (IEC 134).

SYMBOL	PARAMETER	MIN.	MAX.	UNIT
V_{S1}, V_{S2}	DC supply voltage	-	15.5	V
$\pm V_i$	RF input terminal voltage	-	25	V
$\pm V_o$	RF output terminal voltage	-	25	V
P_D	RF input power	-	450	mW
P_L	RF output power (see Fig.2)	-	40	W
T_{stg}	storage temperature range	-30	100	°C
T_h	heatsink operating temperature	-	90	°C

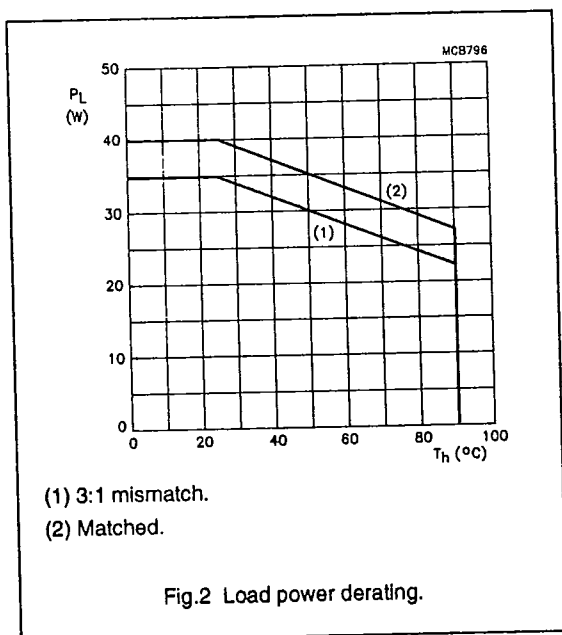

CHARACTERISTICS

$T_h = 25\text{ °C}$; $V_{S1} = V_{S2} = 12.5\text{ V}$; $R_S = R_L = 50\ \Omega$; frequency range = 174 to 200 MHz.

SYMBOL	PARAMETER	CONDITIONS	MIN.	MAX.	UNIT
I_{Q1}	quiescent current	$P_D = 0$	-	25	mA
I_{Q2}	quiescent current	$P_D = 0$	-	55	mA
P_L	RF output power	$P_D = 300\text{ mW}$	27	-	W
G_p	RF power gain	$P_L = 27\text{ W}$	19.5	-	dB
η	efficiency	$P_L = 27\text{ W}$	35	-	%
H_{R2}	2nd harmonic output	$P_L = 27\text{ W}$	-	-30	dBc
H_{R3}	3rd harmonic output	$P_L = 27\text{ W}$	-	-40	dBc
	input VSWR with respect to 50 Ω	$P_L = 27\text{ W}$	-	2:1	

VHF amplifier module

BGY145C

T-74-09-01

APPLICATION INFORMATION

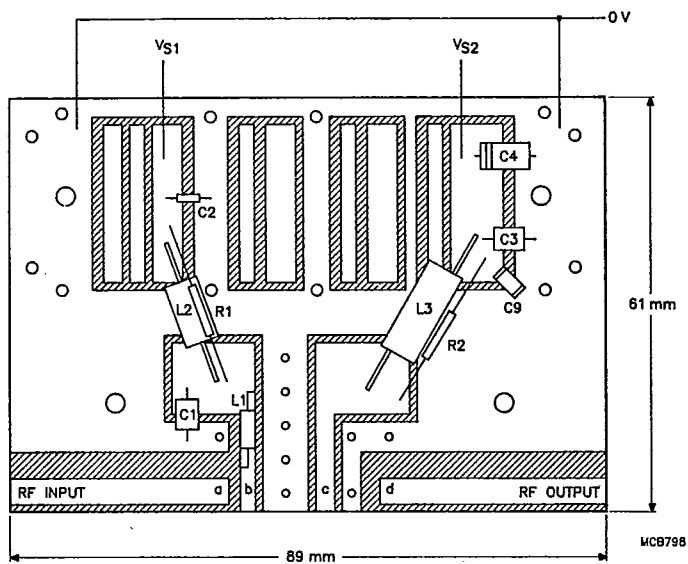

Epoxy fibre-glass board, 1/16 inch thick, $\epsilon_r = 4.5$.

L2 to be 90 degrees to L3.

Track widths 'a' and 'd' (50Ω) = 4 mm.

Track width 'b' = 2.5 mm.

Track width 'c' = 3 mm.

Circles indicate the positions of through rivets.

Fig.3 Test jig.

LIST OF COMPONENTS (Fig.3)

DESIGNATION	DESCRIPTION	VALUE	DIMENSIONS
C1, C3	63 V miniature polyester film capacitor	470 nF	
C2	35 V tantalum bead capacitor	4.7 μ F	
C4	35 V tantalum capacitor	1 μ F	
C9	50 V multilayer ceramic capacitor	47 nF	
L1	4 turns 0.45 mm diameter copper wire		int. dia. 2.5 mm
L2	4 turns 1 mm diameter copper wire		int. dia. 9 mm
L3	12 turns 1 mm diameter copper wire		int. dia. 9 mm
R1, R2	0.5 W resistor	12 Ω	

VHF amplifier module

BGY145C

T-74-09-01

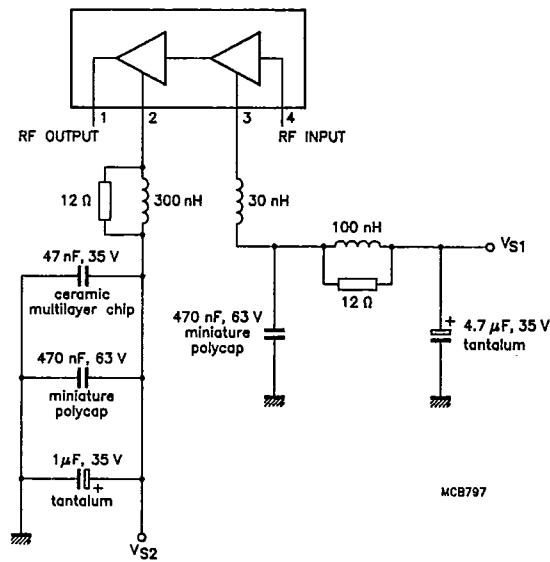

Fig.4 Decoupling arrangement.

STABILITY

The module is stable when operated with a load of up to 3:1 at all phases, providing the operating conditions are as follows:

P_D 15 to 450 mW; $P_L \geq 3$ to ≤ 40 W;
 $V_{S1} = 1.5$ to 15.5 V;
 $V_{S2} = 10.5$ to 15.5 V and $V_{S1} < V_{S2}$.

RUGGEDNESS

The output power of the module into a 50 Ω load will be unchanged after one minute of operation into a load mismatch of 20:1 (any phase), providing maximum ratings are not exceeded.

$V_{S1}, V_{S2} \leq 15.5$ V; $T_h \leq 90$ °C;
 $P_L \leq 40$ W; $P_D < 450$ mW.

RF POWER CONTROL

The module is designed to be operated over a power range up to 27 W, under nominal conditions. The output power may be controlled by adjusting the input power, P_D , or the first stage supply voltage, V_{S1} .

$P_D = 15$ to 450 mW;
 $V_{S1} = 1.5$ V to V_{S2} .

VHF amplifier module

BGY145C

T-74-09-01

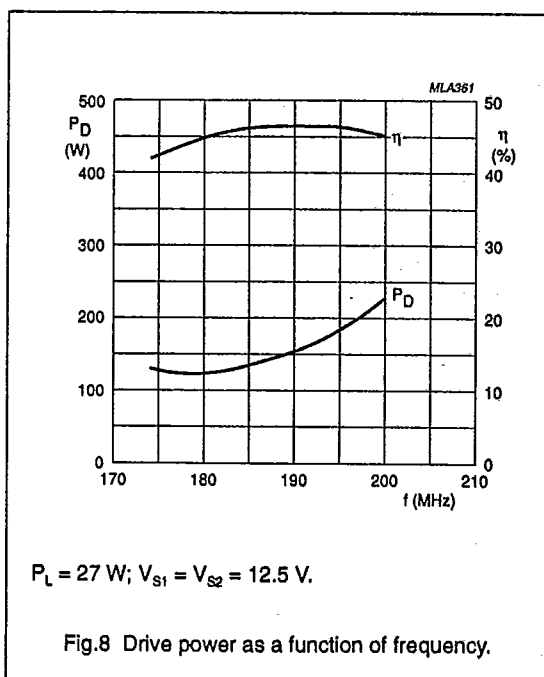
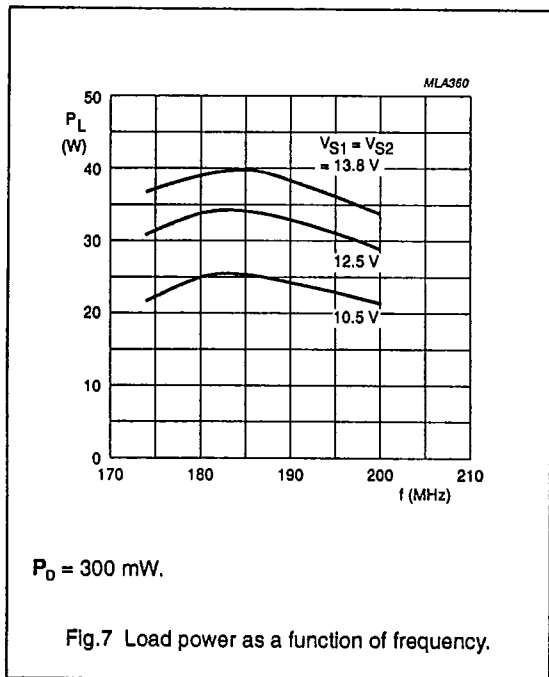
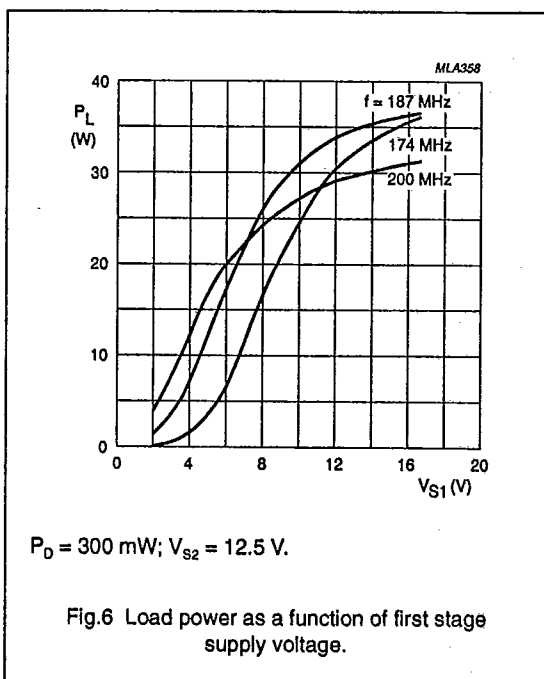
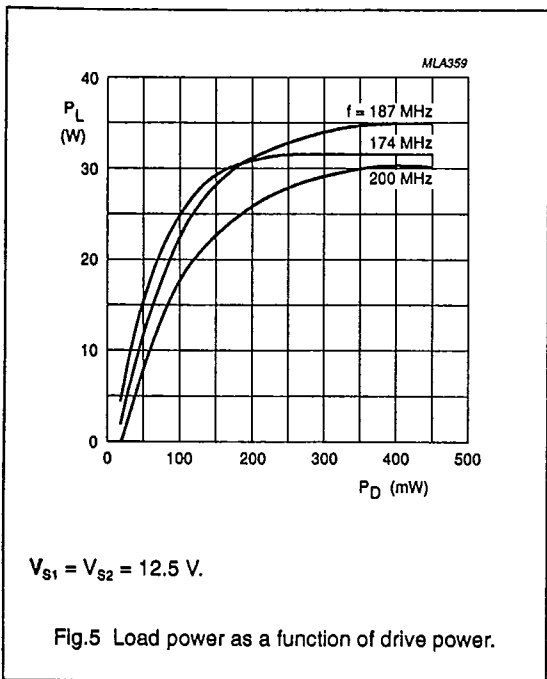

VHF amplifier module

BGY145C

T-74-09-01

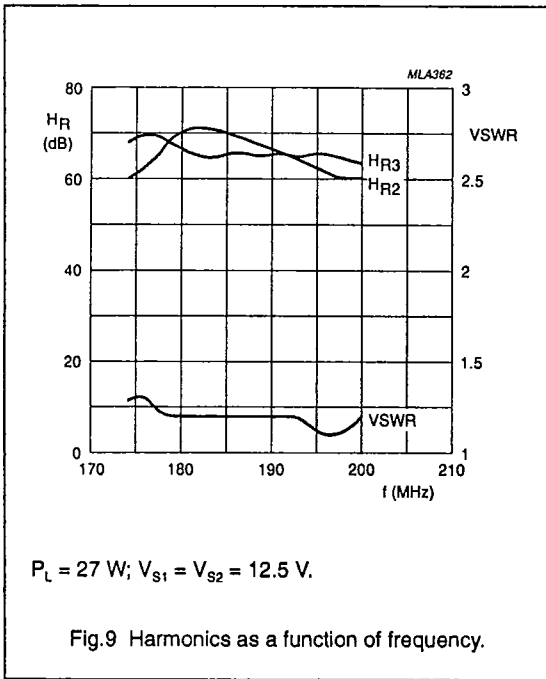

VHF amplifier module

BGY145C

T-74-09-01

PACKAGE OUTLINE

